

NEXANS WEBINAR

RENEWABLE ENERGY

Wind & Solar Energy Trends

May 18, 2021

By: **Nexans Canada**



Nexans
ELECTRIFY THE FUTURE

ATTENTION

AUDIENCE PARTICIPATION

- **Questions can be asked at any time using the chat function on the webinar screen**
- **Any unanswered questions will be followed up through email**
- **This presentation, a recording of the webinar and a brief survey will be emailed to all registrants**

PRESENTERS



Christophe Jollivet

Vice President Projects and
Advanced Solutions,
Nexans Canada



Randy Szilagyi

Applications Engineering
Manager, Nexans Canada



Michael Chlebowski

Polymer Engineering Manager,
Nexans Canada



Pascal Carpentier

Sales Representative for
Power Accessories
Nexans Canada & West of
France



AGENDA

- Nexans Canada Introduction & Corporate Social Responsibility Strategy
- Wind & Solar Energy Market Insights
- Current Wind & Solar Energy Market Solutions
- Sustainable Solutions
- Summary
- Q&A

Nexans is a global leader with a long legacy in Canada



Weyburn, SK

Fergus, ON

Montreal, QC



1911  **canada[®]
wire**

Started with Canada Wire in Toronto, ON

3 Plants

750+ Products

Residential, Commercial, Industrial & Utility



Nexans Canada – Standard Product Portfolio



Residential

- AC90
- CANADEX® NMD90
- HEATEX® NMD90
- INSTAGLIDE® T90 Nylon Cu & Al
- SUPERVEX® NMWU

Commercial

- ACWU90
- Bare Copper
- CORFLEX® Armoured Cu & Al
- INSTAGLIDE® RW90 & RWU90 Cu & Al
- TWU

Renewable Energy

- INSTAGLIDE® RPVU90 Cu
- INSTAGLIDE® RPVU90 Al
- ENERGEX® Medium Voltage 90°C 15 to 46 kV
- ENERGEX® Medium Voltage 105°C
- ACSR

Industrial

- CP-100 Railway Signal
- DriveRx® VFD
- FIREX® TECK90 – 600 V, 1 kV & 5 kV
- FIREX® Medium Voltage Armoured Power Cable

Transmission/Distribution

- Bare ACSR & AACSR
- Bare Aluminum & Al Alloy
- Covered Overhead Distribution Line Wire
- ENERGEX® CN & SP Medium Voltage
- NS75 & NS90
- Street Light Cable
- USEI75 & USEI90 & USEB90

Global Power Accessories

- Separable Connectors
- Terminations
- Joints
- Connectors and Cable Lugs
- Jumper Cables

Nexans Canada – A team driven by service excellence

Engineering Support:

- Full technical support for products manufactured
- Electrical and physical cable properties calculations (i.e. impedances, dimensions)
- Custom engineered solutions to optimize a project from conception to energization
- Conductor ampacity and temperature calculations
- Post installation product support
- Overhead line calculations, including conductor ampacity, temperature, impedance, as well as sag and tension



Industry Education

Our Previous Webinars

- **Emerging Trends for Utility Cables** – click [here](#) to watch it
- **Key 2021 Electrical Code Changes Impacting Wire and Cable** – click [here](#) to watch it
- **15 kV Medium Voltage Armoured Cables** – click [here](#) to watch it
- **Connected Drums - Nexans Canada's Reel Tracking Solution** – click [here](#) to watch it
- **DriveRx® VFD Cable 2.0** – click [here](#) to watch it
- **CORFLEX®** – click [here](#) to watch it
- **2019 Nexans in Canada** – click [here](#) to watch it
- **2021 Canadian Electrical Code Changes** – click [here](#) to watch it
- **Prior VFD webinar** – click [here](#) to watch it

Nexans: Becoming Carbon Neutral by 2030

ACTION 1  4.2%  average annual reduction of company greenhouse gas emissions, particularly on scopes 1&2 	ACTION 4  100%  R&D projects to be dedicated to energy efficiency and energy transition, promoting eco-design and low carbon offers 	ACTION 7  100%  of Nexans employee automobile fleet to switch to either hybrid or electric vehicles 
ACTION 2  100%  of production sites certified ISO 14001 	ACTION 5  100%  Optimization of logistical flows by using multi-modal transport and shorter delivery routes 	ACTION 8  100%  Use of renewable energy via local production or the purchase of decarbonized energy for all location 
ACTION 3  100%  production waste to be recycled 	ACTION 6  100%  of Nexans cable drums to be connected using IoT technologies and recyclable IoT: Internet of Things 	ACTION 9  100%  Deployment of energy efficiency solutions at all sites 

Wind & Solar Energy Market Insights



1. Growing Trends in Wind & Solar Energy
2. Wind & Solar Energy Market Insights in Canada



5 Growing Trends on Wind Energy

1. Larger platform Turbines
2. Energy storage
3. Transmission
4. Repowering
5. Policy



6 Growing Trends on Solar Energy

1. Solar Energy is not cheap
2. Traditional Energy companies will have to adjust
3. Solar battery technology will continue to improve
4. Cost of solar panels will continue to decline
5. Efficiency of solar panels will continue to improve
6. Solar Farm Bill of Materials will evolve

Wind & Solar Energy Market Insights in Canada

The future is bright for renewable energy in Canada

“Despite considerable challenges posed by the global pandemic, Canada ended 2020 with a total wind capacity of **13,588 MW**, a total solar capacity of approximately **3,000 MW**, significant growth in energy storage, and a **positive forecast for 2021.**”

*Robert Hornung, President and CEO,
Canadian Renewable Energy Association (CanREA)*





Wind Farm Stats in Canada

2020 Figures:

- # of wind farms producing power: **307**
- Total Canadian wind capacity: **13,588 MW**
- Ranked **9th** in the world -installed wind capacity
- New wind power generation installed: **166 MW**
- Capacity of wind energy projects currently under construction, for commissioning in 2021: **745 MW**

Source: CanREA



Solar Farm Stats in Canada

2020 Figures:

- # of solar energy installations: **43,000+**
- Total Canadian solar capacity: **3,000 MW**
(approx., sites with greater than 1 MW capacity)
- Ranked **19th** in the world –installed solar capacity
- New solar power generation installed: **70 MW**
- Capacity of solar energy projects currently under construction, for commissioning in 2021: **240 MW**

Source: CanREA

Wind & Solar Farms in Canada

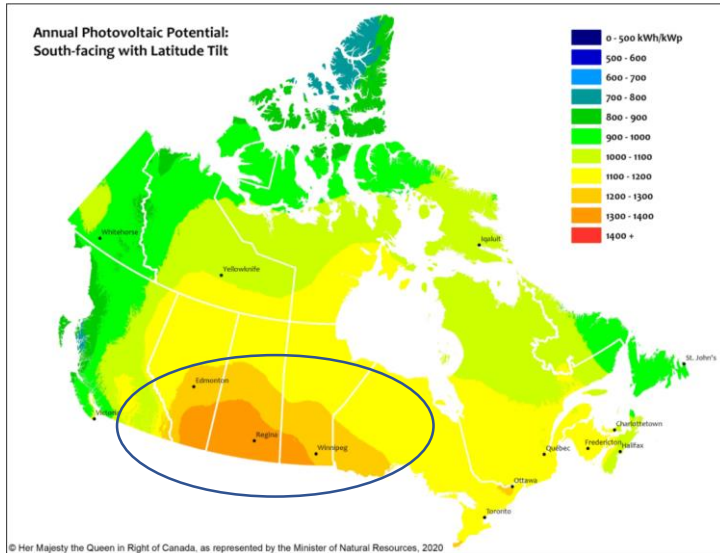

Majority of the future projects are in the HOT zone for the photovoltaic potential

The photovoltaic (PV) potential represents the expected lifetime average electricity production (in kWh) produced per kilowatt of installed photovoltaic DC capacity rated at Standard Test Conditions (STC) for grid-connected PV systems without batteries.

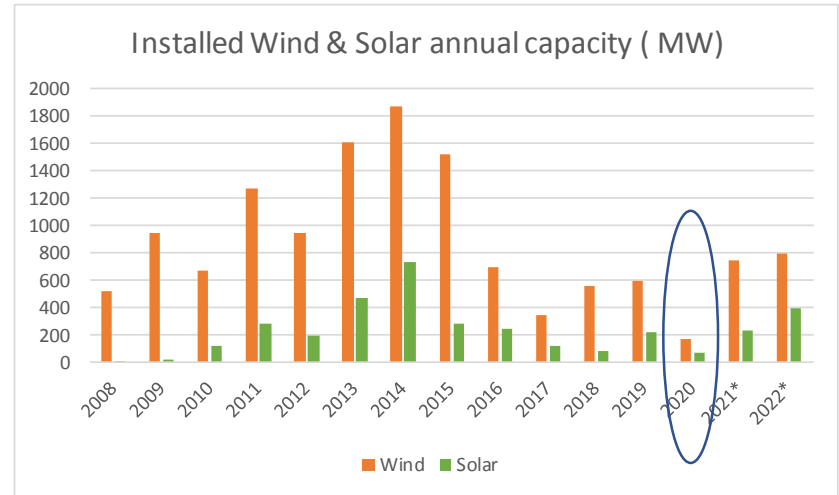

- Ontario Green energy Act boosted Wind & Solar
- COVID-19 put a stop to many Renewable projects in 2020
- Nexans expects between 500 MW to 1 GW/y on average of new installed capacity in the next 3-5 years
- Expect major growth in Alberta and the Prairies



Current Wind & Solar Energy Solutions

1. Solar Low Voltage Products: RPVU90 Cu & Al
2. Solar & Wind Medium Voltage Product
 - Standard 90°C MV
 - Nexans High Temperature MV 105°C
 - Nexans MV Connectors

Solar Energy Solutions

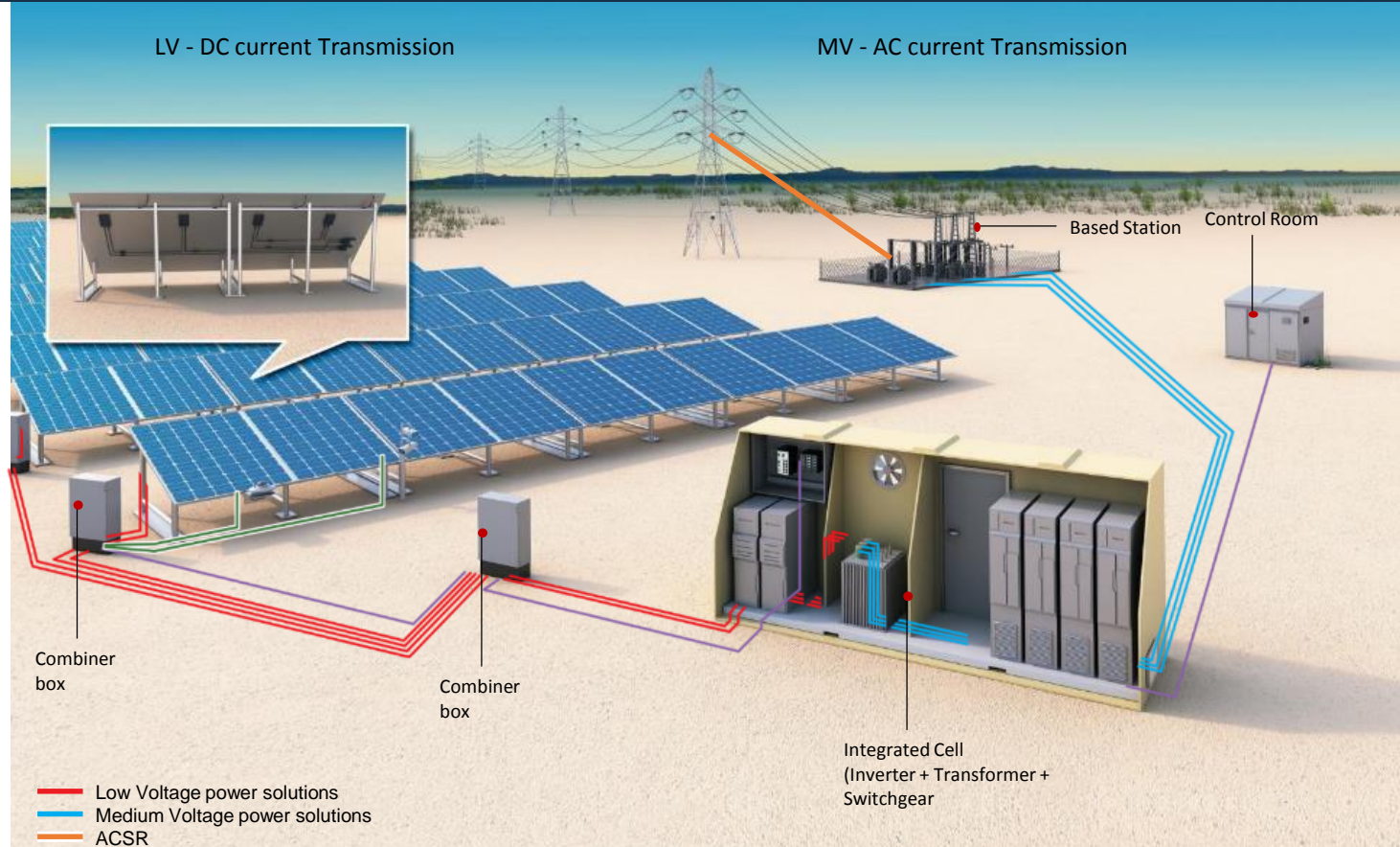

Solar Energy Cables

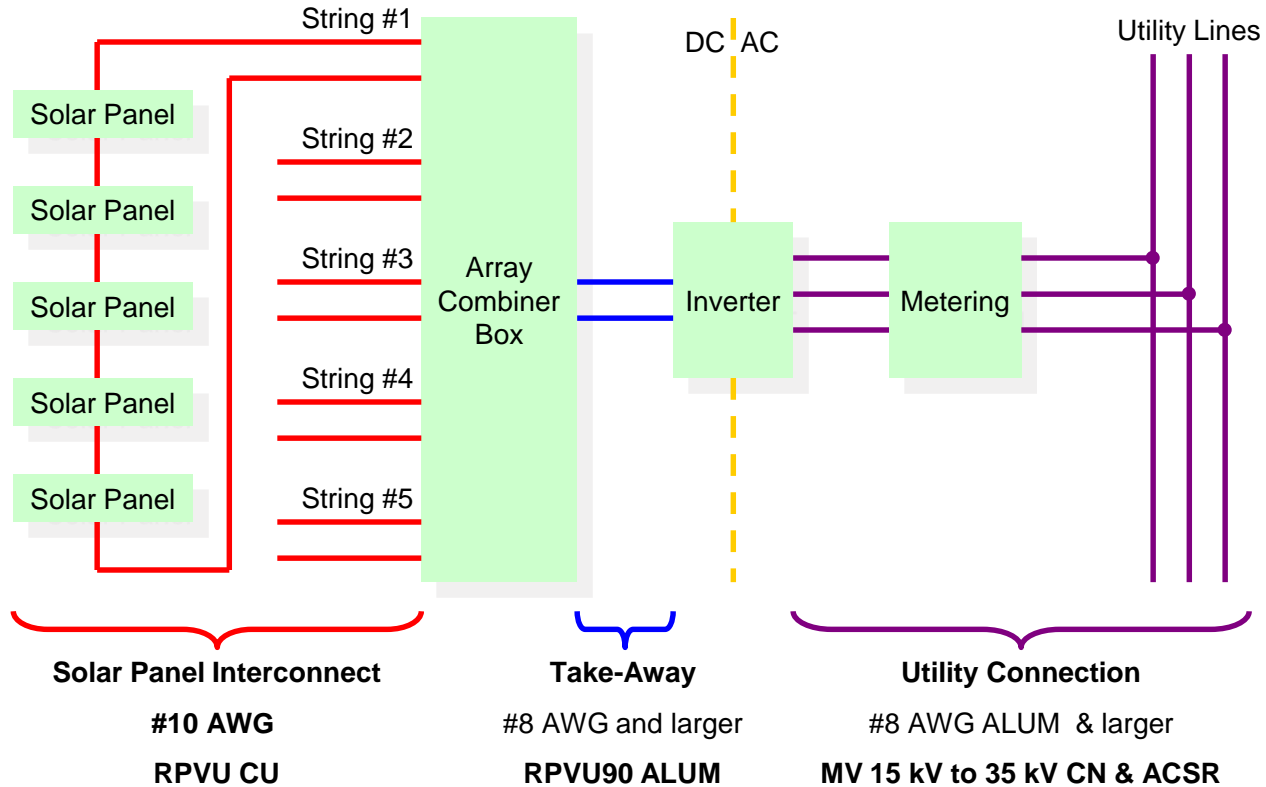

Low Voltage RPVU90 Cable Offers and Standards

Standards Comparison

	CSA 22.2 No.271	UL 4703
Base wire type	RW90	RHW-2
Wire Types	RPV90 / RPVU90	PV Wire
Temperature Rating	90°C dry / 90°C wet	90°C dry / 90°C wet
Voltage Ratings	1 kV, 2 kV	0.6 kV, 1 kV, 2 kV
Flame Retardancy	None mandatory FT-1 optional	FV-1 mandatory VW-1 optional
Sunlight Resistance	80% retention of T&E after 1000 hr aging AND -25°C cold bend	80% retention of T&E after 720 hr aging

Dual marked cables meet both requirements – unnecessary!

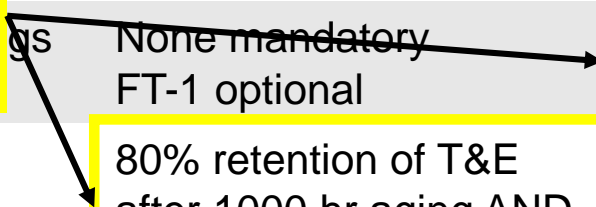

Low Voltage RPVU90 Cable Offers and Standards

Vertical Wire Flame Test



Three different flame markings:

1) Severity of test

FT1 < FV1 < VW1

Canada Only

USA Only

2) Country Restrictions

Low Voltage RPVU90 Cable Offers and Standards

Nexans offers RPVU90 cable constructions aligned to Canadian wire types for Canadian solar farms.

RPV90 / RPVU90, 1 kV / 2 kV, -40°C, SUN RES in black and colours

- Copper 14 AWG – 2000 kcmil, solid or stranded
- Aluminum 12 AWG – 2000 kcmil, stranded

Coming soon, FT1 optional mark for sizes 14 AWG to 8 AWG



Onshore Wind Solutions



— Medium Voltage power solutions

— ACSR

TT Tee connectors



Wind & Solar Medium Voltage Product Offerings

➤ Secondary Distribution (LV)



➤ Primary Distribution (MV 90°C & 105°C)
From 15 to 35 kV, Aluminum or Copper



➤ Overhead & Underground Transmission

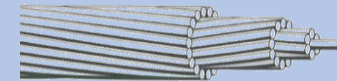

Products manufactured in Canada, less than
1000 kms from any job sites in AB or SK

Medium Voltage Offerings 35 kV

Benefits on the Nexans CSA 105°C rated 35 kV

Standard 90°C MV cable

- **Larger cable diameter** requires wider tranches & duct system
- **Heavier cables** reels to transport and manipulate
- Overall **more expensive** cable solution

Nexans High temperature 105°C MV

- **Reduction in conductor diameter** translates to overall smaller cable diameter to fit into tight duct systems.
- Often conductor size can be reduced one gauge size with near the same ampacity resulting in **weight savings**.
- Often conductor size can be reduced one gauge size with near the same ampacity resulting in **cost savings in metal**.



Nexans High Temperature MV Cables

HUGE savings

35 kV 1250 MCM 90°C CN 1/6 becomes 35 kV 1000 MCM 105°C CN 1/6,

Cables	AMPACITY*		Improvement	
	90C	105C	Amps	%
1000 Al 35kV 25x14 (1/6) CN Encap	629	682	53	8.4
1250 Al 35kV 20x12 (1/6) CN Encap	687	748	61	8.9

Nexans High temperature 105°C MV

- Only 5 Amp difference between the 1250 AL 35 kV 90°C (1/6) CN and the 1000 AL 35 kV **105°C** (1/6) CN.
- 1000 AL 35 kV **105°C** (1/6) CN improves the ampacity by 53 AMP compared to the 1000 AL 35 kV 90°C (1/6) CN and can have significantly lower operating losses due to smaller circulating currents in the neutral.
- In summary, with the Nexans High temperature MV 105°C, you get a **smaller, lighter, easier to install, and less costly solution.**



* Ampacities shown are for illustrative purposes only. Actual ampacity will be dependent on many variables such as soil resistivity and other factors. Consult your cable manufacturer for more information. Highlighted rows show that operation at 105°C can yield very nearly the same ampacity as the next larger conductor size at 90°C.

- Nexans Power Accessories under its brand Name “EUROMOLD”, is a leader in medium and in low high voltage EPDM tee connectors, up to 72,5kV.
- We sell more than 550 000 tee connectors/year.
- We designed compact tee connectors for the new generation of switchgears.
- Nexans MV tee connectors have been approved by:
 - All the main manufacturers in switchgears and transformers
 - All the main wind turbine manufacturers

SIEMENS

Schneider
Electric



Vestas



GOLDWIND

ABB

GRUPO ORMAZABAL

MITSUBISHI
MOTORS

SIEMENS Gamesa
RENEWABLE ENERGY





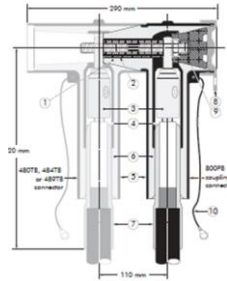
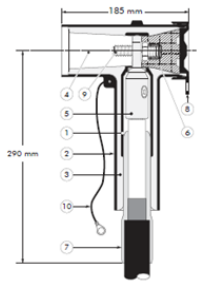

ENERCON
ENERGY FOR THE WORLD

SUZLON
POWERING A GREENER TOMORROW



- Tee and coupling compact connectors suitable for narrow cubicle switchgears
- Compact surge arresters to protect electrical equipment
- Both, for bushing interface 13, and for bushing interface C (only according to IEC standard)
- For conductor size, from #4/0 up 1250 kcmils
- For voltage class up to 42 kV, and ampacity up to 1250 A
- Suitable for conductor with a continuous temperature of 105°C (max)



Bushing Interface	Voltage Class KV	Conductor Size	Plug Type	Connector Item	Current A	Surge Arrester Item
C	24 - 36 - 42	#4/0 to 500 kcmils	Tee Plug 	480TB	1250	800SA
C	24 - 36 - 42	#4/0 to 500 kcmils	Coupling Plug 	800PB	1250	800SA
C	24 - 36 - 42	350 to 1250 Kcmils	Tee Plug 	484TB	1250	800SA
C	24 - 36 - 42	350 to 1250 Kcmils	Coupling Plug 	484PB	1250	800SA
E	24 - 36 - 42	#4/0 to 1250 kcmils	Tee Plug 	784TB	1250	800SA 58
E	24 - 36 - 42	#4/0 to 1250 kcmils	Coupling Plug 	804PB-58	1250	800SA 58

Matrix to select :

- Tee connector Item
- Coupling connector item
- Surge arrester item

Inputs to select:

- Interface Bushing?
- Voltage class?
- Conductor size?
- Plug type?

Tee connector:

- To connect 1x cable on 1x bushing (784TB)

Coupling Connector:

- To connect 2x cables on the same bushing
- Assembly of 784TB + 804PB-58

Surge Arrester:

- To protect electrical equipment
- 800SA or 800SA 58
- Assembly of 784TB + 800SA 58

Unique Sustainable Services and Solutions

- 1. Recycling & Scrap Recovery Services**
- 2. Connected Reels Tracking Solution**



Recycling & Scrap Management: How it works

OBJECTIVE: Reduce environmental footprint & optimize costs and return credits in a simplified process.



Connected Reels Tracking Solution

Get more from your cable reel data



Real-Time Location

Track
your reel fleet

Stock Management

Optimize
your stock and
follow your residual
lengths

Project Management

Monitor
your connected
reels in a project
mode

15,000 Nexans Connected Reels successfully installed worldwide!
And already >100 in Canada

How It Works

Hardware

Infrastructure

Software

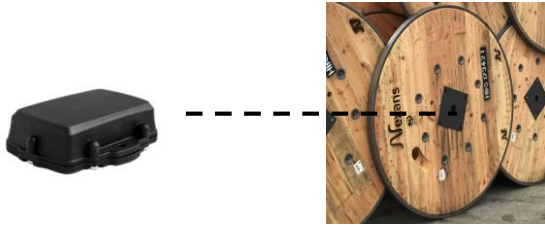

**Devices embedded
in our reels**



**CLOUD NATIVE
2G/3G/4G/LTE-M**

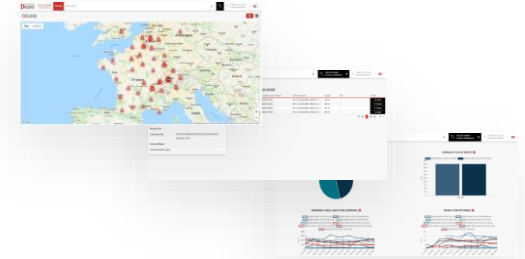

**SAAS platform connected
with your ERP**



Geolocation

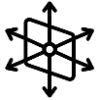

Movement Sensors
For Remaining length



3 years
battery life



Real-Time



Real-Time Alerts





Summary

- Nexans Canada is a **vertically integrated manufacturer**
- Our products are all **Made in Canada** which means no risk on exchange rate, shorter lead times and no potential border or transportation delays
- Provide **local engineering & technical support**
- Reviewed **renewable energy market trends in Canada**
- Discussed wind and solar energy product offerings → **RPU90 Cu & Al and MV**
- Showcased our **105°C MV cables and Tee Connectors**
- Sustainable solutions: **Recycling & Scrap Solution & Connected Reel tracking Solution**

Questions



Chat

[type question here]

To: Send question to Staff

test 2
Webinar ID: 725-323-619

 GoToWebinar

A red arrow points from the right side of the chat window towards the 'Send question to Staff' dropdown menu.

Thank you for your attention!



Contact:

Christophe Jollivet

Vice President Projects and Advanced Solutions
christophe.jollivet@nexans.com

Randy Szilagyi

Applications Engineering Manager
randy.szilagyi-ext@nexans.com

Michael Chlebowski

Polymer Engineering Manager
michael.chlebowski@nexans.com

Pascal Carpentier

Sales Representative for Power Accessories
pascal.carpentier@nexans.com

www.nexans.ca

